

COMPETENCE B4130-1

The Versatile Built-in Oven

Operating Instructions

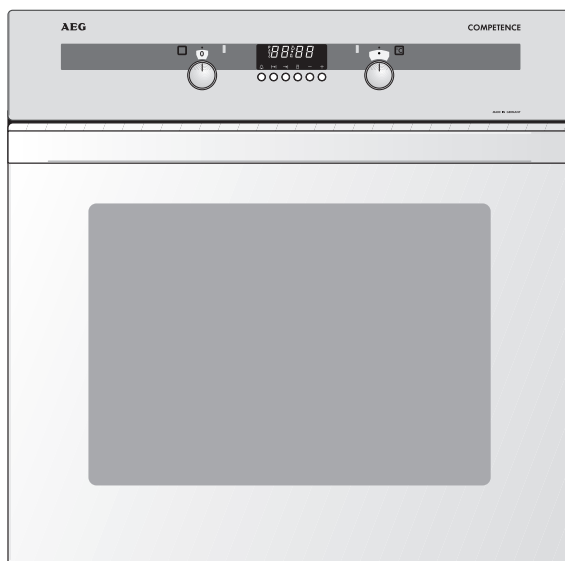

Dear customer,

Please read these operating instructions carefully.

Pay particular attention to the section "Safety information" on the first few pages. Please retain these operating instructions for later reference. Pass them on to possible new owners of the appliance.

The following symbols are used in the text:



Safety instructions

Warning: Information concerning your personal safety.

Important: Information on how to avoid damaging the appliance.



Information and practical tips



Environmental information

1. These numbers indicate step by step how to use the appliance.
2. ...
3. ...

In the event of any technical problems please contact your nearest CUSTOMER SERVICE CENTRE at any time. (Addresses and telephone numbers may be found in the appendix under "Customer Service Centres").

You should also refer to the section "Service".

Contents

Safety	5
Disposal	6
Description of the Appliance	7
General Overview	7
Control Panel	7
Oven Features	8
Oven accessories	9
Before Using for the First Time	10
Setting the Time	10
Initial Cleaning	11
Using the Oven	12
Switching the Oven On and Off	12
Oven Functions	13
Inserting the Shelf and Universal Baking Tray	15
Inserting/Removing the Fat Filter	16
Working with the Electronic Clock	17
Function display:	18
Mechanical Door Lock	26
Uses, Tables and Tips	27
Baking	27
Baking Table	29
Tips for baking	32
Pies and Gratin Table	33
Frozen Ready Meals Table	34
Roasting	35
Roasting table	37
Grilling	39
Grilling Table	39
Defrosting	40
Defrosting table	40
Preserving	41

Cleaning and Care	43
Exterior of the Appliance	43
Oven Interior	43
Fat Filter	43
Accessories	43
Shelf Support Rails	44
Oven Lighting	45
Cleaning the Oven Ceiling	46
Oven Door	47
Oven Door Glass	48
What to do if	50
Technical Data	51
Oven Interior Dimensions	51
Regulations, Standards, Directives	51
Index	54
Service	55



Safety

Electrical Safety

- The appliance may only be connected by a **registered specialist**.
- In the event of any faults or damage to the appliance: remove fuses or switch off.
- It is **not permissible** to clean the appliance with a steam or high pressure cleaner for safety reasons!
- **Repairs** to the appliance may **only be carried out by specialists**. Repairs carried out by inexperienced persons may cause injury or serious malfunctioning. If your appliance needs repairing, please contact your local AEG Service Force Centre or your specialist dealer.

Child Safety

- Never leave children unsupervised when the appliance is in use.

Safety whilst Using

- This appliance is intended to be used for cooking, frying and baking food in the home.
- Take care when connecting electric appliances to sockets nearby. Do **not** allow connecting leads to come into contact with hot rings or to catch beneath the hot oven door.
- **Warning: Risk of burns!** The interior of the oven becomes hot during use.
- Using ingredients containing alcohol in the oven may create an alcohol-air mixture that is easily ignited. In this case, open the door carefully. Do not have embers, sparks or naked flames in the vicinity when opening the door.

To Avoid Damaging Your Appliance

- Do not line your oven with aluminium foil and do not place a baking tray or dish on the oven floor, otherwise the oven enamel will be damaged by the resulting build up of heat.
- Juice from fruit that drips from baking trays will leave marks that cannot be removed. For very moist cakes, use the universal baking tray.
- Do not put any weight on the oven door when it is open.
- Never pour water directly into the hot oven. The enamel may be damaged.
- Using force, especially on the edges of the front glass panel, may break the glass.
- Do not store inflammable objects in the oven. They may ignite when the oven is switched on.
- Do not store moist food in the oven. The enamel may be damaged.



Disposal

Disposing of the packaging material

All materials used can be fully recycled.

Plastics are marked as follows:

- >PE< for polyethylene, as used for the outer wrapping and the bags inside.
- >PS< for polystyrene foam, e.g., as used for the padding materials. They are completely free of CFCs.

Disposal of old appliances



Warning: Before disposing of old appliances please make them inoperable so that they cannot be the source of danger.

To do this, disconnect the appliance from the mains supply and remove the mains lead.

To protect the environment, it is important that worn out appliances are disposed of in the correct manner.

- The appliance must not be disposed of with household rubbish.
- You can obtain information about collection dates or public refuse disposal sites from your local refuse department or council.

Description of the Appliance

General Overview

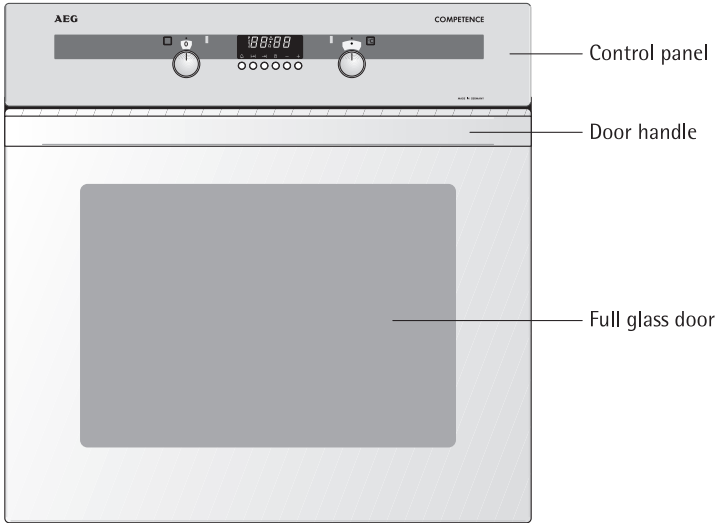

Control Panel

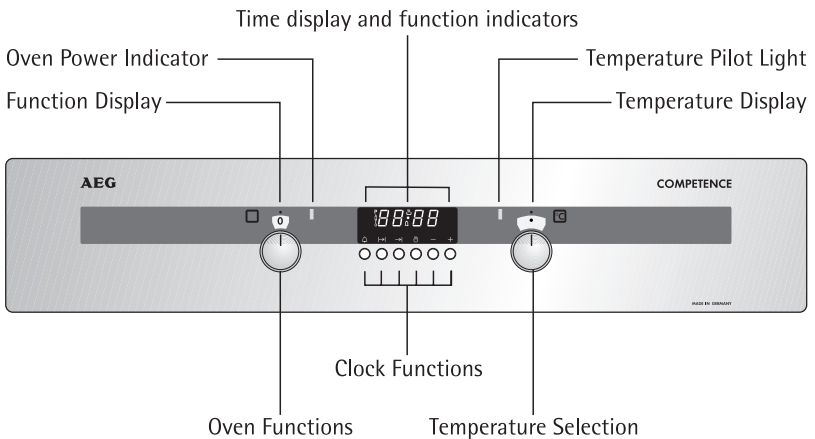

Oven Features

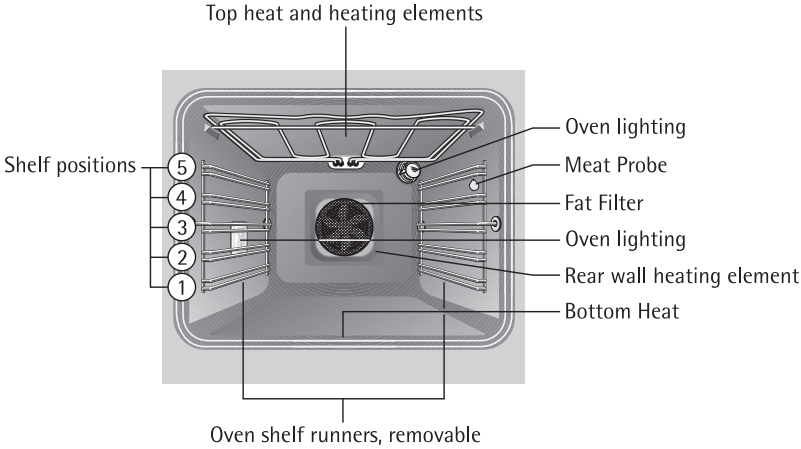

Oven Steam Outlet

Steam from the oven is fed out between the upper edge of the door and the control panel.

Oven accessories

Combination shelf

For dishes, cake tins, items for roasting and grilling.

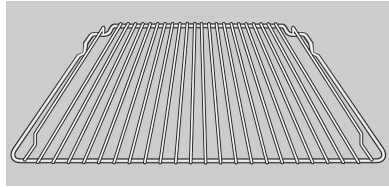

Fat tray

For roasting or for collecting fat.

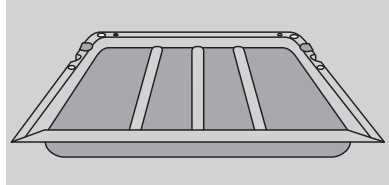

Baking tray

For cakes and biscuits.

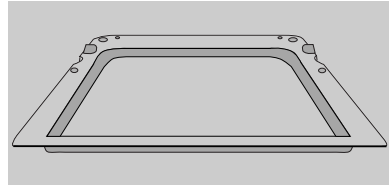

Meat probe

For determining exactly how far joints of meat are cooked.

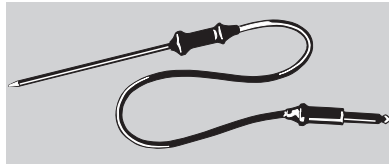

Before Using for the First Time

Setting the Time

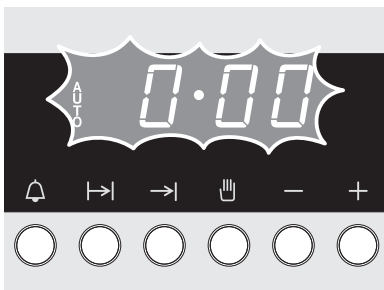

i The oven will only function if the time is set.

The time display will flash after the appliance has been connected to the mains or following a power failure.



4. Press the  buttons briefly.



5. Start setting the current time within 5 seconds, using the  or  buttons.



The appliance is ready for use.

Initial Cleaning

Before using the oven for the first time you should clean it thoroughly.



Caution: Do not use any caustic, abrasive cleaners! The surface could be damaged.



To clean metal fronts use commercially available cleaning agents.

1. Turn the oven function switch to oven lighting .
2. Remove all accessories and the shelf support rails and wash them with warm water and washing up liquid.
3. Then wash out the oven with warm water and washing-up liquid, and dry.
4. Wipe the front of the appliance with a damp cloth.

Using the Oven

Switching the Oven On and Off

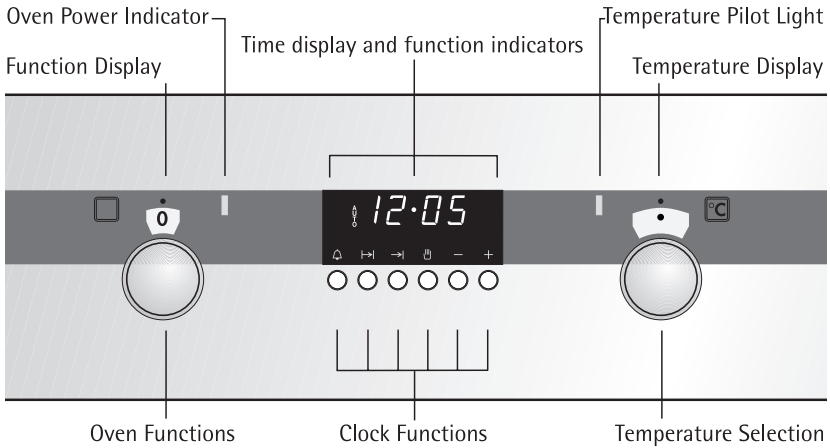

1. Turn the "oven functions" switch to the required function.
2. Turn the "temperature selection" switch to the required temperature.
The yellow oven power indicator will remain on while the oven is in use.
The red temperature pilot light comes on while the oven is heating up.
3. To switch off the oven turn the "oven functions" switch and the "temperature selection" switch to the off position.



Cooling fan

The fan comes on automatically when the oven is in use in order to keep the surfaces of the appliance cool. Once the oven has been switched off the fan continues running to cool down the appliance and then switches itself off automatically.

Oven Functions

The oven has the following functions:

Oven lighting

With this function you can **illuminate** the oven interior, e.g., for cleaning.

The heating element is not in use.

Pizza & baking

For baking cakes on **one level** and for pastries that need more browning and a crispy base. These include such foods as pizza, quiche lorraine, and cheese cake.

Set oven temperatures 20–40 °C lower than when using conventional. Conventional is used and in addition the fan is switched on.

Fan cooking

For **baking on up to three levels** at the same time.

Set oven temperatures 20–40 °C lower than when using conventional.

The rear wall heating element is used and in addition the fan is switched on.

Conventional

For **baking and roasting on one level**.

The conventional heating elements are in use.

Bottom heat

For **crisping and browning** cakes with **crispy bases**.

The bottom heating element is in use.

Defrost

To **begin to thaw and to defrost** such items as flan, butter, bread, fruit or other **frozen foods**.

For this function the fan operates **without** heating.

Grill

For **grilling** flat foods placed on the **middle of the shelf** such as steaks, escalopes or fish, or for **toasting**.

The grill heating element is in use.

Dual grill

For **grilling larger quantities** of flat foods such as steaks, escalopes or fish, or for **toasting**.

Top heat and the grill heating element are in use.

Rotitherm

For **roasting** larger pieces of meat or poultry on one level. This function is also suited to **cooking foods au gratin** and **browning**.

The grill heating element and fan operate alternately.

Inserting the Shelf and Universal Baking Tray



Anti-tip device

All slide-in units have a small bulge on the left and right. This bulge is an anti-tip device and must always point to the rear of the oven.

Tray or universal baking tray:

The anti-tip device must point towards the rear of the oven.

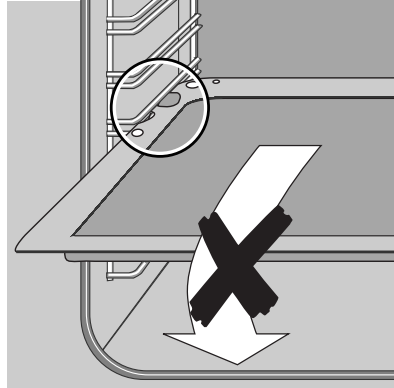

Inserting shelf:

Insert the shelf unit with both guide rails pointing upwards. The anti-tip device must point downwards and be positioned to the rear of the oven compartment.

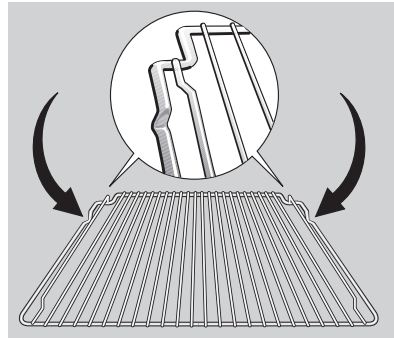

Inserting shelf and tray:

When the shelf unit and universal baking tray are used together, carefully place the shelf anti-tip device in the bulges on the tray.

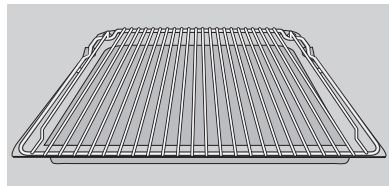

Inserting/Removing the Fat Filter

The fat filter protects the rear wall heating element against splashes of fat when roasting.

Inserting the fat filter

Holding the fat filter by the tab, insert the two retainers into the opening on the rear wall of the oven (fan opening) from the top downwards.

Removing the fat filter

Take hold of the tab on the fat filter and remove by pulling upwards.

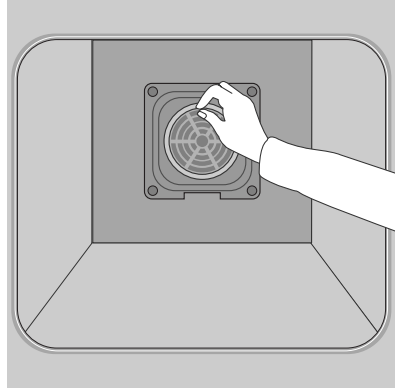

Working with the Electronic Clock

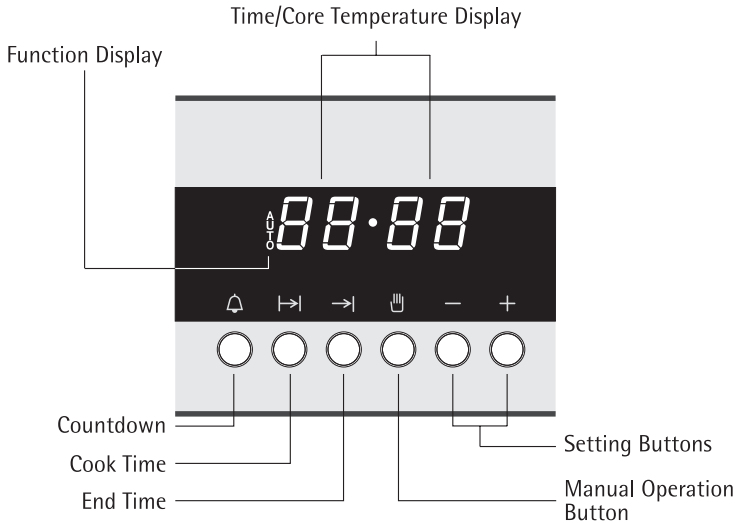

Clock functions:

Manual operation

Pressing button  transfers the oven from automatic to manual operation.

Countdown

To set a countdown. A signal sounds after the time has elapsed. This function does not affect the functioning of the oven.

Cook time

To set how long the oven is to be in use.

End time

To set when the oven is to switch off again.

Meat probe

For switching off the oven precisely when a set core temperature has been reached.





Function display:

AUTO

The "AUTO" sign lights up when an automatic program has been set, and flashes when the program is completed.





General information

- Within 5 seconds after setting a clock function the required times can be set or changed using the  or  buttons.
- **After working with the cook time /end time  functions the appliance must be changed from automatic operation to manual operation by pressing button .**

Countdown

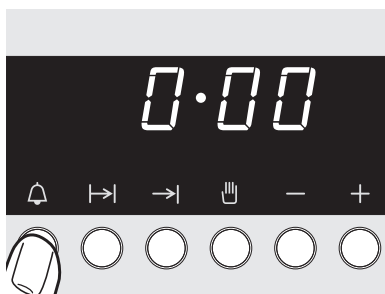
1. Press countdown button .



2. Using the  or  buttons, set the required time.

It is possible to find out how much time remains by pressing the countdown button again.

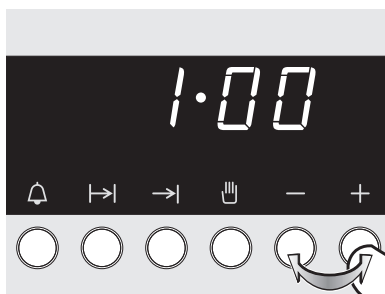

The time display will show the current time again a few seconds after countdown has been set.

An acoustic signal will sound for 7 minutes after the countdown has expired.





The acoustic signal can be cancelled by pressing any button.

Cook time

1. Press button .



2. Using the  or  buttons, set the required cooking time (max. 10 hours).

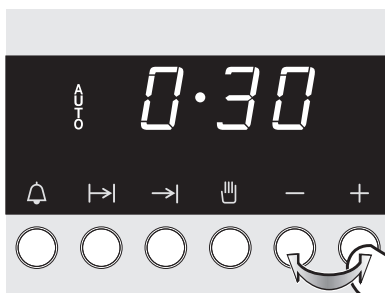

After approx. 5 seconds the display reverts to the time. The symbol "AUTO" indicates that the oven has been changed to automatic operation.





When the time has expired a signal sounds for 7 minutes and the oven switches off.

3. Stop the acoustic signal and the programme by pressing button .



Cook Time and End Time Combined



Cook time  and end time  can be used together if the oven is to switch on and off automatically at a **later time**.

1. Selecting Oven Functions and Temperature.



Using the cook time  function set the time required to cook the food.

E.g., 1 hour.



2. Press button .



Using the  or  buttons, set the time at which the appliance is required to switch off.



The symbol "Auto" is illuminated and the time is shown in the display. E.g., 12:05 hrs.

The oven will switch on automatically at the calculated time. E.g., at 13:05 hrs.

And it will switch off again after the entered cook time has expired. E.g., at 14:05 hrs.

When the time has expired the "AUTO" symbol flashes, an acoustic signal sounds for 7 minutes and the oven switches off.

3. Switch off the programme by pressing button .



Changing the time



The time can only be changed if there is no automatic programme set (cook time or end time).

1. Press the buttons briefly.



2. Using the or buttons, set the current time.



3. After 5 seconds the clock will show the set time.



The appliance is ready for use.

Meat Probe

For switching off the oven precisely when a set core temperature has been reached.

The meat probe is a practical tool when using conventional, hot air and rotitherm.

Two temperatures should be observed:

- the oven temperature: see Roasting Table
- the core temperature: see Meat Probe Table



Warning: Only the meat probe supplied with the appliance should be used! If a replacement is required use only an original spare part!

1. Push the meat probe into the food that is to be cooked until the tip reaches the centre of the food.
2. Push the plug fully into the socket in the side wall of the oven.
The suggested temperature, 80, will appear on the right. The current core temperature, e.g., 22, will appear on the left.

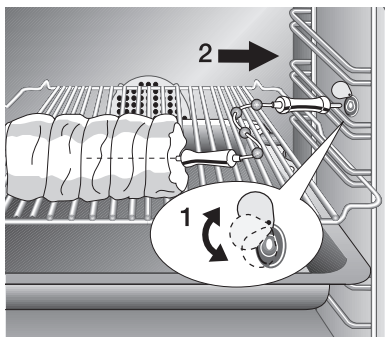



The core temperature is displayed from 20 and above.

3. Set the required oven function and temperature.

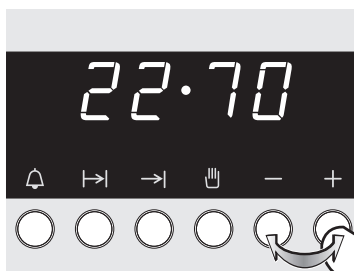

4. Set the required core temperature using the \oplus or \ominus buttons.
E.g., 70



5. As soon as the current core temperature has reached the set core temperature a signal will sound and the oven will switch off automatically. Press button  to switch off the signal.



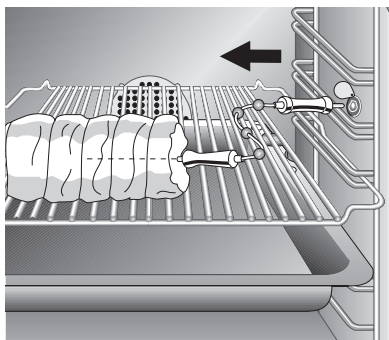

 **Warning:** The meat probe is hot! There is a risk of being burned when removing the plug and tip of the probe!

6. Remove the meat probe plug from the socket, then take the cooked food from the oven with the meat probe still inserted.
7. Switch off the oven functions and temperature. If necessary, switch off the appliance.



Changing the core temperature.

It is possible to change the selected temperature afterwards by pressing  or  several times.

Mechanical Door Lock

When the appliance is delivered, the door lock is deactivated.

Activate the door lock

Pull the safety catch forwards until it locks in place.

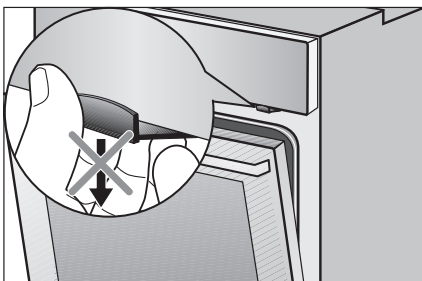
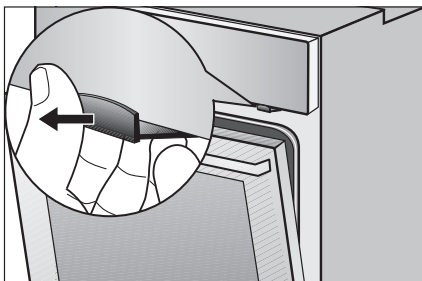

Open the oven door:

1. Shut the door.
2. Press the safety catch and keep it depressed.
3. Open the doors.

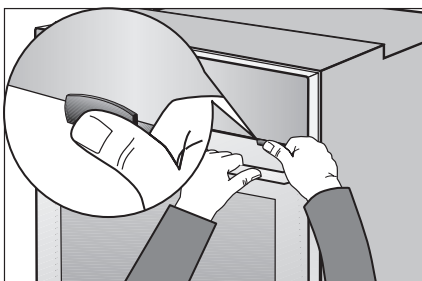

Close the oven door

Close the door without pressing the safety catch.

Deactivating the door lock



Press the safety catch back into the panel.



Switching off the appliance does not cancel the mechanical door lock.



Uses, Tables and Tips

Baking



Use the pizza & baking , fan cooking  or conventional  oven functions for baking.

i **Remove the fat filter when baking**, as otherwise the baking time is longer and the surface will brown unevenly.

Baking tins

- Coated baking tins and tins made of dark metal are suitable for conventional  heat.
- Light metallic, glass and ceramic containers are also suitable for pizza & baking  and fan cooking .

Shelf positions

- Pizza & baking  or conventional  can both be used for baking on one level.
- Using fan cooking  it is possible to bake flat, dry cakes and pastries on up to 3 baking trays at the same time

1 Baking tray
e.g., shelf position 3

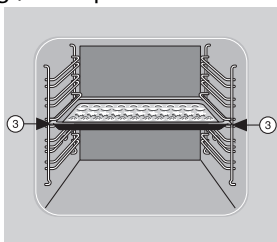

1 Baking tin:
e.g., shelf position 1

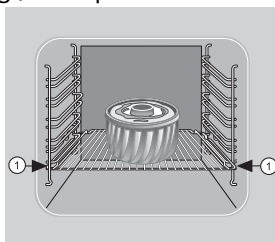

2 Baking trays:
Shelf positions 1 and 4

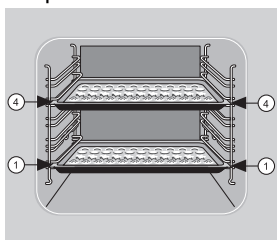

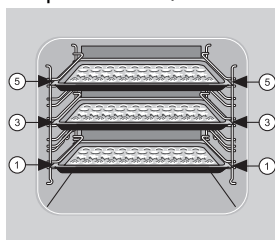

3 Baking trays:
Shelf positions 1, 3 and 5





General information

- Always count the shelf positions from the bottom upwards.
- Insert baking trays with the sloped edge to the front!
- Always place cake tins in the middle of the shelf.
- With pizza & baking  or conventional  you can also bake two items simultaneously by placing the tins next to one another on the shelf. There is no significant increase in baking time.

Notes on the baking tables

In the tables you will find information on temperatures, cooking times and shelf positions for a selection of dishes.

- The temperatures and cooking times are for guidance only since these are dependent on the mixture, quantity and cake tin used.
- We recommend that you use the lower temperature initially and only select a higher temperature if necessary, e.g., if more browning is required or the cooking time is too long.
- If you cannot find specific information for one of your own recipes, use information given in a similar recipe for guidance.
- When cakes are baked on trays or in tins on more than one oven position at once the baking time may be increased by 10-15 minutes.
- Items that might drip (e.g., pizzas, fruit flans) should only be prepared on one level.
- Variations in the height of the item to be baked can lead to different degrees of browning at the start of baking. In this case **please do not change the temperature setting**. Differences in the degree of browning will balance out during baking.





For longer cooking times switch off the oven approx. 10 minutes before the end of the cooking time to make use of the residual heat. Unless otherwise stated, the information in the tables assumes starting with a cold oven.

Baking Table

Baking on one shelf position

Type of cake or pastry	Pizza Et baking 		Conventional 		Time
	Shelf position from bottom	Temperature °C	Shelf position from bottom	Temperature °C	For both functions Hrs.: Mins.
Cakes in cake tins					
Ring-shaped or bowl-shaped cakes	1	150-160	1	160-180	0:50-1:10
Madeira cake/ king cake	1	140-160	1	150-170	1:10-1:30
Sponge cake	1	150-160	1	160-180	0:25-0:40
Shortcrust pastry flan base	3	170-180	2	190-210 ¹	0:10-0:25
Sponge flan base	3	150-170	2	170-190	0:20-0:25
Covered apple flan	1	150-170	1	170-190	0:50-1:00
Savoury flan (e.g., quiche lorraine)	1	160-180	1	190-210	0:30-1:10
Cheesecake	1	140-160	1	170-190	1:00-1:30
Cakes and pastries on baking trays					
Plaited roll/ring	3	160-170	3	170-190	0:30-0:40
Fruit loaf	3	150-170 ¹	3	160-180 ¹	0:40-1:00
Bread (rye bread) initiallythen	1	180-200 ¹ 140-160	2	250 ¹ 160-180	0:20 0:30-1:00
Cream puffs/eclairs	3	160-170 ¹	3	190-210	0:15-0:30
Swiss roll	3	150-170 ¹	3	180-200 ¹	0:10-0:20
Dry streusel cake	3	150-160	3	160-180	0:20-0:40
Butter cake/sugar cake	3	160-170 ¹	3	190-210 ¹	0:15-0:30

Type of cake or pastry	Pizza & baking 		Conventional 		Time For both functions Hrs.: Mins.
	Shelf position from bottom	Temperature °C	Shelf position from bottom	Temperature °C	
Fruit flan (with a yeast dough/sponge base) ²	3	150-170	3	170-190	0:25-0:50
Fruit flans on shortcrust pastry base ¹	3	160-170	3	170-190	0:40-1:20
Tarts with delicate fillings (e.g., curd cheese, cream, sugar-topped cakes)	-	-	3	160-180¹	0:40-1:20
Pizza (with deep topping) ²	1	180-200	1	190-210 ¹	0:30-1:00
Pizza (thin)	1	200-220	1	230-300 ¹	0:10-0:25
Unleavened bread	1	200-220	1	270-300 ¹	0:08-0:15
Flat sweet or savoury pies	1	180-200	1	210-230	0:35-0:50
Biscuits					
Shortcrust biscuits	3	150-160	3	170-190 ¹	0:06-0:20
Small piped biscuits	3	140-150	3	160-180	0:10-0:40
Sponge fingers	3	150-160	3	170-190	0:15-0:20
Meringues	3	80-100	3	100-120	2:00-2:30
Macarons	3	100-120	3	120-140	0:30-0:60
Small pastries made with yeast dough	3	160-170	3	170-190	0:20-0:40
Small pastries made with puff pastry	3	170-180¹	3	190-210 ¹	0:20-0:30
Bread rolls	3	180-200¹	3	180-220 ¹	0:20-0:35

1) Pre-heat the oven

2) Use the combination/fat tray or the fat tray!

Information printed in bold type indicates the **preferred oven function** in each case.



Baking on several shelf positions

Type of cake or pastry	Fan cooking 			Time Hours: Mins.
	Shelf position from bottom		Tempera- ture °C	
	2 Levels	3 Levels		
Cakes and pastries on baking sheets				
Cream puffs/eclairs	1/4	-	160-180 ¹	0:35-0:60
Dry streusel cake	1/4	-	140-160	0:30-0:60
Biscuits				
Shortcrust biscuits	1/4	1/3/5	150-160	0:15-0:35
Small piped biscuits	1/4	1/3/5	140-150	0:20-0:60
Sponge fingers	1/4	-	160-170	0:25-0:40
Meringues	1/4	-	80-100	2:10-2:50
Macaroons	1/4	-	100-120	0:40-1:20
Small pastries made with yeast dough	1/4	-	160-170	0:30-0:60
Small pastries made with puff pastry	1/4	-	170-180 ¹	0:30-0:50
Bread rolls	1/4	-	180-190 ¹	0:30-0:55

Tips for baking

Baking result	Possible cause	Solution
The cake is under-cooked at the bottom	Wrong shelf position	Insert the cake at a lower shelf position
The cake collapses (is sticky, soft in the middle, damp patches)	Cooking temperature too high	Set to a lower temperature
	Cooking time too short	Increase cooking time Cooking times may not be reduced by using a higher cooking temperature
	Too much liquid in mixture	Next time use less liquid. Check that you have beaten the mixture for the correct length of time, particularly when using a food-processor.
Cake is too dry	Cooking temperature too low	Set a slightly higher baking temperature next time
	Cooking time too long	Reduce cooking time
Cake is unevenly browned	Cooking temperature too high and cooking time too short	Set to a lower temperature and increase cooking time
	Mixture is spread unevenly	Spread mixture evenly on the baking tray
	Fat filter is still in position	Remove fat filter
Cooking time too long	Temperature too low	Set a slightly higher baking temperature next time
	Fat filter is still in position	Remove fat filter





Pies and Gratin Table

	Conventional 		Rotitherm 		Time
	Shelf position from bottom	Temp. °C	Shelf position from bottom	Temp. °C	Hrs: Mins.
Pasta bake	1	180-200	1	160-170	0:45-1:00
Lasagne	1	180-200	1	160-170	0:25-0:40
Vegetables au gratin ¹	1	200-220	1	160-170	0:15-0:30
Pizza baguettes ¹	1	200-220	1	160-170	0:15-0:30
Sweet soufflés	1	180-200	-	-	0:40-0:60
Fish pies	1	180-200	1	160-170	0:30-1:00
Stuffed vegetables	1	180-200	1	160-170	0:30-1:00

1) Pre-heat the oven.

Information printed in bold type indicates the **preferred oven function** for the dish.

Frozen Ready Meals Table



Food to be cooked	Shelf position from bottom	Oven function	Temperature	Time
Frozen pizza	3	Conventional 	in accordance with the maker's instructions	in accordance with the maker's instructions
Chips ¹ (300-600 g)	3	Rotitherm 	200-220 °C	15-25 Mins.
Baguettes	3	Conventional 	in accordance with the maker's instructions	in accordance with the maker's instructions
Fruit flan	3	Conventional 	in accordance with the maker's instructions	in accordance with the maker's instructions

1) Comment: Turn chips 2-3 times during cooking.



When frozen foods are used the trays inserted may distort during cooking. This is because of the large differences in temperature between the frozen item and the oven. Once the trays have cooled the distortion will disappear again.

Roasting

Use the rotitherm  or conventional  oven functions for roasting.

Ovenware for roasting

- Any heat-resistant dish is suitable for roasting (refer to the manufacturer's instructions!).
- If the dish has plastic handles, check that they are heat-resistant (refer to manufacturer's instructions!).
- Large roasts can be roasted **directly on the universal baking tray or on the shelf with the universal baking tray underneath** (e.g. turkey, goose, 3-4 chickens, 3-4 knuckles of veal).
- We recommend that all lean pieces of meat should be roasted **in a casserole dish with a lid** (e.g. veal, marinated beef, pot roast, frozen meat.) In this way the meat will retain its juices.
- In order to obtain a tasty outside crust we recommend roasting pieces of meat in a **casserole dish without a lid** (e.g. roast pork, lamb and mutton, meat loaf, duck, 1-2 knuckles of veal, 1-2 chickens, small fowl, roast beef, fillets, game).



Tip: The oven will be less dirty if you always use a dish for roasting!



Shelf positions

- Please see the following table for the shelf positions to be used.



Notes on the roasting table

Information is given in the table on suitable oven functions, temperature settings, cooking times and shelf positions for various types of meat. The information is for guidance.

- We recommend roasting meat and fish **with a minimum weight of 1kg in the oven.**
- In general the conventional  oven function is particularly suitable for very lean meat such as fish or game. For all other types of meat (particularly poultry) we recommend the rotitherm  function.
- To stop meat juices or fat burning onto dishes or the oven, we recommend adding a little liquid to the roasting dish.
- Turn the joint as required (after 1/2 - 2/3 of the cooking time).







Tip: Baste large joints and poultry several times during cooking with the meat juices. This will produce better roasting results.



Switch off the oven approx. 10 minutes before the end of the cooking time to make use of the residual heat.

Roasting table



Type of meat	Quantity	Conventional 		Rotitherm 		Time
	Weight	Shelf position from bottom	Temperature °C	Shelf position from bottom	Temperature °C	Hours:Minutes.
Beef						
Pot roast	1-1.5 kg	1	200-250	-	-	2:00-2:30
Roast beef or fillet						per cm of thickness
- rare	per cm of thickness	1	250-270 ¹	1	190-200	0:05-0:06
- medium rare	per cm of thickness	1	250-270 ¹	1	180-190	0:06-0:08
- well done	per cm of thickness	1	210-250 ¹	1	170-180	0:08-0:10
Pork						
Shoulder, neck ham joint	1-1.5 kg	1	210-220	1	160-180	1:30-2:00
Chop, smoked loin chop	1-1.5 kg	1	180-190	1	170-180	1:00-1:30
Meat loaf	750 g-1 kg	1	170-180	1	160-170	0:45-1:00
Knuckle of pork (pre-cooked)	750 g-1 kg	1	210-220	1	150-170	1:30-2:00
Veal						
Roast veal	1 kg	1	210-220	1	160-180	1:30-2:00
Knuckle of veal	1.5-2 kg	1	210-225	1	160-180	2:00-2:30
Lamb						
Leg of lamb, roast lamb	1-1.5 kg	1	210-220	1	150-170	1:15-2:00
Saddle of lamb	1-1.5 kg	1	210-220	1	160-180	1:00-1:30

Type of meat	Quantity	Conventional 		Rotitherm 		Time
	Weight	Shelf position from bottom	Temperature °C	Shelf position from bottom	Temperature °C	Hours:Minutes.
Game						
Saddle of hare, haunch of hare	up to 1 kg	3	220-250 ¹	3	160-170	0:25-0:40
Saddle of venison	1.5-2 kg	1	210-220	1	160-180	1:15-1:45
Haunch of venison	1.5-2 kg	1	200-210	1	160-180	1:30-2:15
Poultry						
Poultry portions 4-6 pieces	per 200 - 250 g	3	220-250	3	180-200	0:35-0:50
Chicken halves 2-4 pieces	per 400-500 g	3	220-250	3	180-200	0:35-0:50
Chicken, poulard	1-1.5 kg	1	220-250	1	170-180	0:45-1:15
Duck	1.5-2 kg	1	210-220	1	160-180	1:00-1:30
Goose	3.5-5 kg	1	200-210	1	150-160	2:30-3:00
Turkey	2.5-3.5 kg 4-6 kg	1	200-210 180-200	1	150-160 140-150	1:30-2:00 2:30-4:00
Fish (steaming)						
Whole fish	1-1.5 kg	2/3	210-220	2/3	160-170	0:45-1:15

1) Pre-heat the oven.

Information printed in bold type indicates the **preferred oven function** for the dish.

Grilling

To grill use the grill  oven function or dual grill  with temperature setting .



Important: Always grill with the oven door closed.



Always pre-heat the empty oven **for 5 minutes using the grill functions!**

Ovenware for grilling

- Use the shelf unit and universal tray together for grilling.

Shelf positions

- For grilling flat foods you should mainly use the **4th shelf position from the bottom.**

Notes on the grilling table

The grilling times are only for guidance and will vary depending on the type and quality of meat or fish.

- Grilling is particularly suitable for flat pieces of meat and fish.
- Turn the food halfway through grilling.

Grilling Table

Food for grilling	Shelf position from bottom	Grilling time	
		1st side	2nd side
Rissoles	4	8-10 mins.	6-8 mins.
Fillet of pork	4	10-12 mins.	6-10 mins.
Grilled sausages	4	8-10 mins.	6-8 mins.
Beef fillet steaks, veal steaks	4	6-7 mins.	5-6 mins.
Fillet of beef, sirloin (approx. 1 kg)	3	10-12 mins.	10-12 mins.
Toast ¹	3	2-3 mins.	2-3 mins.
Toast with topping	3	6-8 mins.	-

1) Do not use the universal baking tray together with the grilling shelf unit.

Defrosting

To defrost, use the defrost  oven function without setting a temperature.

Dishes for defrosting

- Remove packaging and place the food on a plate on the shelf.
- Do not use a plate or dish to cover as these significantly increase the defrosting time.

Shelf positions

- Insert the shelf in the **1st position from the bottom** to defrost.

Notes on the defrosting table

The table below offers some guidance on defrosting times.

Defrosting table

Dish	Defrosting time Mins.	Final defrosting time Mins.	Note
Chicken, 1000 g	100-140	20-30	Place the chicken on an upside-down saucer on a large plate. Halfway through cooking turn or cover with foil.
Meat, 1000 g	100-140	20-30	Halfway through cooking turn or cover with foil.
Meat, 500 g	90-120	20-30	Halfway through cooking turn or cover with foil.
Trout, 150 g	25-35	10-15	Do not cover
Strawberries, 300 g	30-40	10-20	Do not cover
Butter, 250 g	30-40	10-15	Do not cover
Cream, 2 x 200 g	80-100	10-15	Do not cover (Cream may be whipped when some of it is still slightly frozen)
Flan, 1400 g	60	60	Do not cover

Preserving

For making preserves, use the bottom heat  oven function.

Preserving jars

- When making preserves, use only commercially available jars of the same size.



Jars with twist-off tops or with a bayonet fastening and metal containers are not suitable.

Shelf positions

- Use the **1st shelf position from the bottom** for making preserves.

Notes on preserves

- Use the universal tray for preserves. There is room for up to six jars, each with a capacity of 1 litre.
- The jars should all be filled to the same level and closed.
- Position the jars on the universal baking tray so that they do not come into contact with one another.
- Pour about ½ litre of water into the universal baking tray so that there is sufficient moisture in the oven.
- As soon as bubbles begin to appear in the first jars (for 1-litre jars this takes about 35-60 minutes), switch off the oven or reduce the temperature to 100° C (see table).

Preserving Table

The stated times and temperatures are for guidance only.

Preserves	Temperature in °C	Preserving time until bubbles form Mins.	Continued cooking at 100°C Mins.	in switched off oven standing time
Soft fruit				
Strawberries, blueberries, raspberries, ripe gooseberries	160-170	35-45	-	-
Unripe gooseberries	160-170	35-45	10-15	-
Fruit with stones				
Pears, quinces, plums	160-170	35-45	10-15	-
Vegetables				
Carrots	160-170	50-60	5-10	60
Mushrooms	160-170	40-60	10-15	60
Gherkins	160-170	50-60	-	
Mixed Pickles	160-170	50-60	15	-
Kohlrabi, peas, asparagus	160-170	50-60	15-20	-
Beans	160-170	50-60	-	-
Plum purée	160-170 50	45 -	6-8 hrs.	- -

Cleaning and Care



Warning: For safety reasons cleaning the appliance with a steam jet cleaner or high-pressure water cleaner is **not permissible!**

Exterior of the Appliance

Wipe the front of the appliance with a soft cloth dipped in warm soapy water.

- Do not use scourers, caustic cleaners or abrasive items.
- Use commercially available cleaners for metal fronts.

Oven Interior



Warning: The oven must be switched off and cold before cleaning.

Clean the appliance after each use. This is the easiest way to remove spills and prevents them being burnt on.

1. Switch on the oven lighting  when cleaning.
2. Every time you use the oven, wipe it out afterwards with water and washing-up liquid, then dry. Do not use any abrasive items.
3. Remove stubborn marks with special oven cleaners.



Important: Always follow the manufacturer's instructions when using oven spray!

Fat Filter

1. Clean the fat filter in hot water and washing up liquid or in the dishwasher.
2. Badly burned on soiling can be removed by boiling the filter in a little water to which 2-3 tablespoonsful of dishwasher cleaner has been added.

Accessories

Wash all slide-in units (shelf unit, baking tray, shelf support rails etc.) after each use and dry well. Soak briefly to make them easier to clean.

Shelf Support Rails

The shelf support rails on the left and right hand sides of the oven can be removed for cleaning the side walls.

Removing the shelf support rails

First pull the front of the rail away from the oven wall (1) and then un-hitch at the back (2).

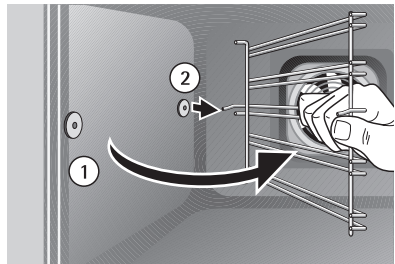
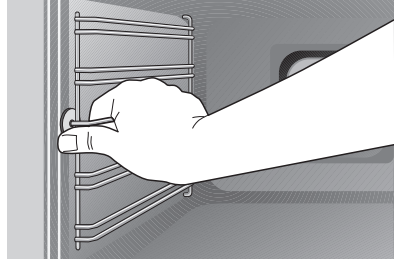

Fitting the shelf support rails



Important! The rounded ends of the guide rails must be pointing forwards!

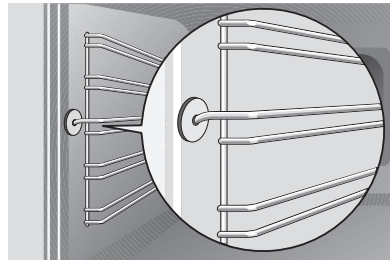

To re-insert, first hook the rail into place at the back (1) and then insert the front and press into place (2).

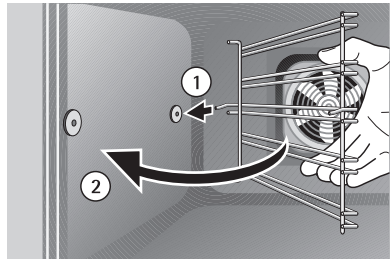

Oven Lighting



Warning: There is a danger of electric shock! Prior to changing the oven light bulb:

- Switch off the oven!
- Remove the fuses in the fuse box or switch off the circuit breaker.



Place a cloth on the oven floor to protect the oven light and glass cover.

Changing the rear oven light/Cleaning the glass cover

1. Remove the glass cover by turning it anti-clockwise and then clean it.
2. If necessary:
replace bulb with a 40 watt, 230 V, 300 °C heat-resistant, oven light bulb.
3. Refit the glass cover.

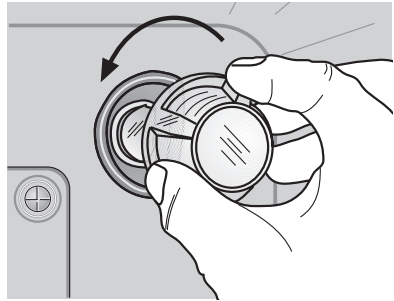

Changing side oven light/Cleaning glass cover

1. Remove the left shelf support rail.
2. Remove the glass cover with the aid of a narrow, blunt implement (e.g., teaspoon) and clean it.
3. If necessary:
replace bulb with a 25 watt, 230 V, 300 °C heat-resistant, oven light bulb.
4. Refit the glass cover.
5. Insert the shelf support rail.

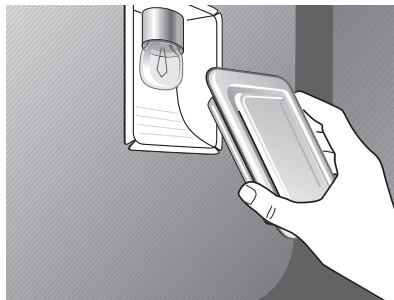
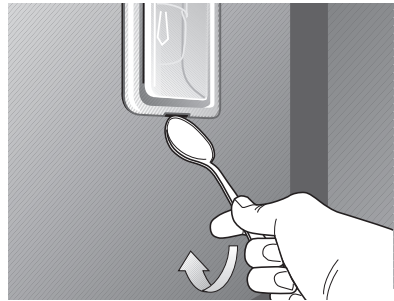

Cleaning the Oven Ceiling

The upper heating element can be folded down to make it easier to clean the oven ceiling.

Folding down the heating element



Warning: Only fold down the heating element when the oven is switched off and there is no risk of being burnt!

1. Remove the side shelf support rails.
2. Grip the heating element at the front and pull it forwards and out over the support lug on the inner wall of the oven.
3. The heating element will now fold down.



Caution: Do not use force to press the heating element down! The heating element might break.

Cleaning the oven ceiling

Repositioning the heating element

1. Move the heating element back up towards the oven ceiling.
2. Pull the heating element forwards against the spring pressure and guide it over the oven support lug.
3. Settle it onto the support.
4. Insert shelf support rail.



Important: The heating element must be positioned correctly and securely on both sides above the support lug on the inner wall of the oven (2).

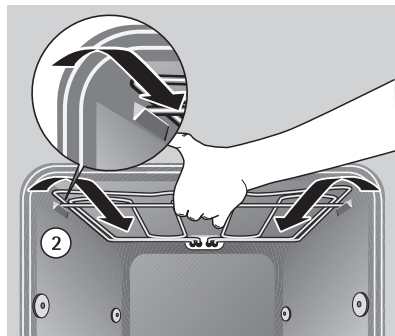
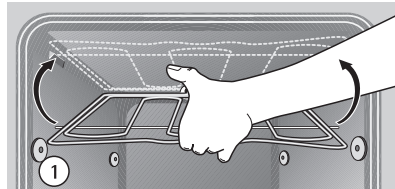
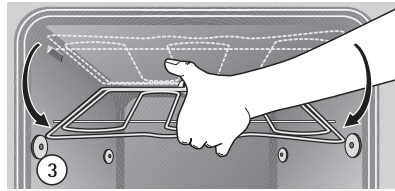
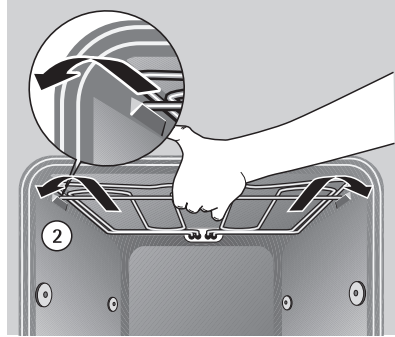

Oven Door

The oven door of your appliance may be removed for cleaning.

Removing the oven door

1. Open the oven door completely.
2. **Completely** fold back the **brass-coloured clamping lever** on **both** door hinges.
3. Grip the oven door with both hands on the sides and close it to about **3/4 going past the point of resistance**.
4. Pull the door away from the oven (**Caution: heavy!**).
5. Place the door, with the outer surface downwards, on a soft, flat surface, for example a blanket, to avoid scratches.

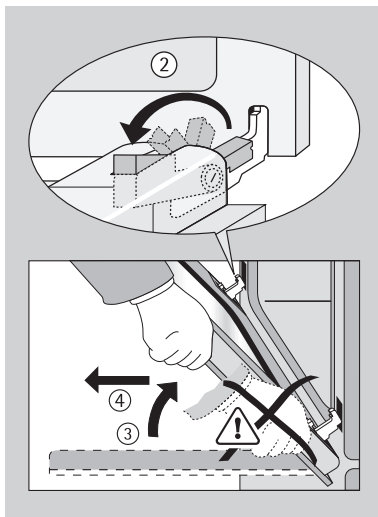

Hanging the oven door

1. With both hands take hold of the sides of the door from the side on which the handle is positioned.
2. Hold the door at an angle of approx. 60°.
3. Slide the door hinges **simultaneously** as far as possible into the two slots on the right and left at the bottom of the oven.
4. Lift the door up until resistance is met and then open fully.
5. Lift the brass-coloured clamping levers on both door hinges back to their original position.
6. Close the oven door.

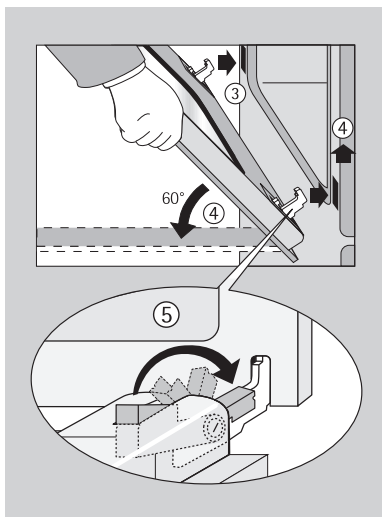

Oven Door Glass

The oven door is fitted with three glass panels mounted one behind the other. The inner panels may be removed for cleaning.



Warning: Carry out the following steps only when the oven door is un-hinged! When left on its hinges, the door could rise rapidly due to the lighter weight when the glass is removed and could cause injury.



Important: Using force, especially on the edges of the front glass panel, may break the glass.

Removing the top door glass

1. Unhinge the oven door and place it on a soft, flat surface with the handle facing down.
2. Take hold of the upper glass panel at the lower edge and slide it against the spring pressure in the direction of the oven door handle until it is free at the base.
3. Raise the panel **gently** at the base and pull out.

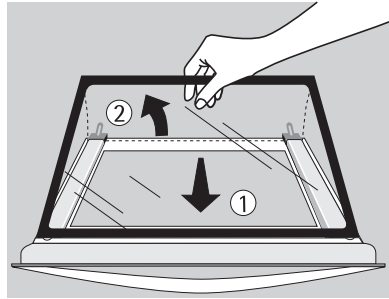

Removing the middle door glass

1. Grip the bottom edge of the middle glass panel and push it in the direction of the oven door handle until it is free at the base.
2. Raise the panel gently at the base and pull out.

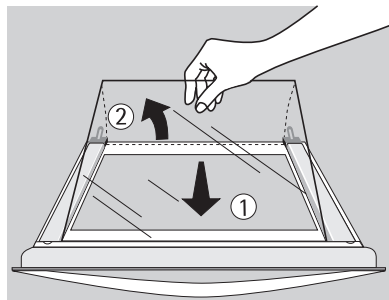

Clean the glass door panels

Inserting the middle door glass

1. Insert the middle glass panel at an angle from above into the section of the door in which the handle is located.
2. Lower the middle glass panel and slide it under the lower bracket towards the lower door edge as far as it will go.

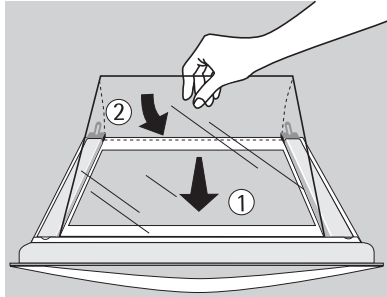

Inserting the upper door glass

1. Insert the upper glass panel at an angle from above into the section of the door in which the handle is located.
2. Lower the glass panel. Lay the panel against the spring on the lower door edge in front of the retaining section on the handle side, and **slide it under the retaining section**. The glass panel must be firmly in position!

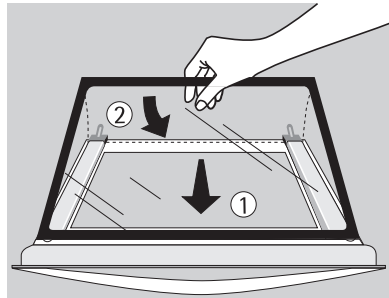

Re-hang the oven door

What to do if ...

Symptom	Possible cause	Remedy
The oven does not heat up.	The oven has not been switched on.	Switch on the oven.
	The time has not been set.	Set the time.
	The necessary settings have not been made.	Check the settings.
	The circuit breaker (at the household fuse box) has tripped or the fuse has blown.	Check the circuit breaker or fuse. If the circuit breaker trips or the fuse blows several times, please contact an approved electrician.
The oven lighting does not come on.	The oven light bulb is faulty.	Change the oven light bulb (see Cleaning and Care).

If you are unable to remedy the fault with the above assistance, please contact your specialist dealer or AEG Service Force Centre.



Warning: Repairs to the appliance may only be carried out by approved service engineers! Repairs carried out by inexperienced persons may cause serious injury to the user.

If the appliance has been used improperly, the customer service engineer's visit or that of the specialist dealer will not be free of charge, even during the warranty period.



Due to the cold front of your appliance, the inner door glass may steam over briefly if you open the door during or shortly after roasting or baking.

Technical Data

Oven Interior Dimensions

Height x Width x Depth	31 cm x 41 cm x 41 cm
Capacity (usable capacity)	52 l

Regulations, Standards, Directives

This appliance meets the following standards:

- EN 60 335-1 and EN 60 335-2-6
relating to the safety of electric appliances for household use and similar purposes and
- EN 60350 or DIN 44546 / 44547 / 44548
relating to the operating features of household electric cookers, hobs, ovens, and grills.
- EN 55014-2 / VDE 0875 Part 14-2
- EN 55014 / VDE 0875 Part 14 / 1999-10
- EN 61000-3-2 / VDE 0838 Part 2
- EN 61000-3-3 / VDE 0838 Part 3
relating to basic requirements for electromagnetic compatibility (EMC).

CE This appliance complies with the following EC directives:

- 73/23/EEG dated 19.02.1973 (Low Voltage) including amendment 90/683/EEG
- 89/336/EEG dated 03.05.1989 (EMC including Amendment 92/31/EEG)
- 93/68/EEG (markings and labelling).

Index

A

Accessories9, 15

B

Baking tray 9

Bottom heat 13

C

Child safety system 26

Cleaning

accessories 43

initial cleaning 11

oven door 47

shelf support rails 44

Clock 17

Changing the Time 23

Cook time 20

Countdown 19

Combination shelf 9

Control panel 7

Conventional 13

Customer service 55

D

Defrosting14, 40

Description of the appliance 7

Dishes with toppings 33

Disposal 6

Door 47

Dual grill 14

F

Fan cooking 13

Fat filter 43

Fat tray 9

G

Grill 14

Grilling 39

I

Insert anti-tip 15

L

Lighting 45

M

Meat Probe 24

O

Oven

accessories9

door47

functions13

light45

P

Pizza & baking13

R

Ready meals34

Repairs 5

Roasting35

Rotitherm14

S

Safety5

Shelf15

Shelf support rails44

Soufflés33

Steam outlet8

T

Tables and tips27

U

Universal baking tray15

Using the oven12

W

What to do if50

Service

The section "What to do if..." lists some faults that you can remedy yourself. Look there first if a fault occurs.

Is it a technical fault?

Then contact your nearest customer service centre. (Addresses and telephone numbers can be found under "Customer Service Centres".)

Always prepare in advance for the discussion. By doing so you will make it easier to diagnose the fault and decide whether customer service is necessary.

Please make a note of the following information as accurately as possible:

- What form does the fault take?
- Under what circumstances does the fault occur?

Prior to the telephone call it is imperative that you make a note of the following appliance code numbers that are given on the rating plate:

- PNC Code (9 digits),
- S No Code (8 digits).

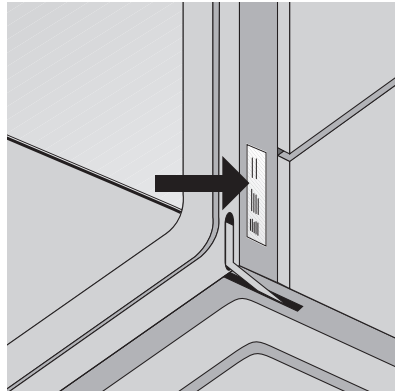

We recommend that you record the code numbers here so that you always have them to hand:

PNC

S No.

When do you incur costs even during the warranty period?

- if you could have remedied the fault using the fault table (see section "What to do if ..."),
- if the customer service technician has to make several journeys because he was not provided with all the relevant information before his visit and therefore, for example, has to fetch spare parts. These multiple trips can be avoided if you prepare for your phone call as described above.

 **From the Electrolux Group. The world's No. 1 choice.**

The Electrolux Group is the world's largest producer of powered appliances for kitchen, cleaning and outdoor use. More than 55 million Electrolux Group products (such as refrigerators, cookers, washing machines, vacuum cleaners, chain saws and lawn mowers) are sold each year to a value of approx. USD 14 billion in more than 150 countries around the world.

AEG Hausgeräte GmbH
Postfach 1036
D-90327 Nürnberg

<http://www.aeg.hausgeraete.de>

© Copyright by AEG

822 947 593-C-290403-09

Subject to change without notice